

Tab- What's New- Tech

CP Pistons Cylinder Honing Recommendations For CPN & CPN2

For use with our CPN and CPN2 piston rings, we recommend plateau honing with a cylinder bore cross hatch angle of 35-40 degrees.

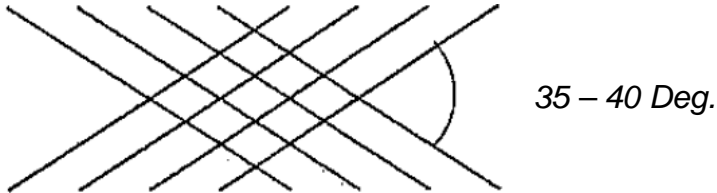

To reach this roughness, the manufacturers of honing machines and accessories recommend using for a gray cast iron engine block and Nikasil cylinders.

- Conventional stones #220 - #280 grit or
- Diamond stones #325 - #550 grit

After honing with either the conventional or diamond stone, the same manufacturers suggest to finish your honing by smoothing the surface with a fine grit conventional abrasive (#400 - #600 grit) or to sweep the bores with a flexible brush or a nylon bristle plateau honing tool. This is necessary to get rid of jagged peaks and folded or torn material.

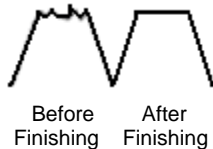

Important Note:

Be sure to confirm with your honing equipment manufacturer that the recommended stone grit will produce the following Rz and Ra roughness recommendations.

Rz = 59 - 138 μ in [=1.5 - 3.5 μ m] or
Ra = 15 - 35 μ in [=0.4 - 0.9 μ m]

CP Piston Ring Recommendations

Failure to check ring gap can result in severe engine failure. The following end gap recommendations are general guidelines. The best ring gap for any particular engine and application varies. Increased clearance is generally needed for forced induction, nitrous, filled blocks, endurance racing and other extreme applications. The final end gap suitable for the engine is the full responsibility of the engine builder. If you have any questions, please call 949-567-9000 for technical support.

Determining Ring Gap

To determine the ring end gap look for your application in the proceeding table. ALL BORES MUST BE CONVERTED TO INCHES. Example: Bore size is 81mm – to find top ring end gap for a street application: **81mm/25.4= 3.189 inches**
 $(3.189 \times .005) = .016"$

.016" is the minimum allowable clearance.

Ring End Gap Chart

Application	Top Ring	Second Ring	Oil Ring
Street/Hi Performance	Bore x .0045/.005"	Bore x .005/.006"	Min. .015"
Drag Racing Circle Track	Bore x .006"	Bore x .0065/.007"	Min .015"
Nitrous/Turbo Supercharged	Bore x .0065/.007"	Bore x .007/.008"	Min .015"
Motorcycle/ATV	Bore x .005"	Bore x .006"	Min .015"

Ring Orientation Diagram

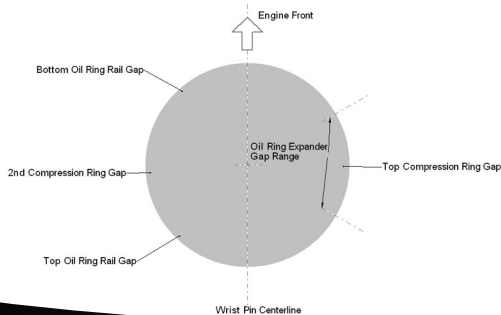

Disclaimer/Warranty

Due to the nature of high performance applications, CP Pistons/Pankl products are sold without any warranty of merchantability or fitness for purpose, express or implied. It is expressly understood and agreed between CP Pistons/Pankl and purchasers that as part of the bargain between CP Pistons/Pankl and purchasers, consideration of doing business with each other, all purchasers take, select, and purchase said products and services from CP Pistons/Pankl "as is" and "with all faults" and CP Pistons/Pankl shall provide purchaser with a full and complete opportunity to examine parts, inventory or services when purchasing from CP Pistons/Pankl. CP Pistons/Pankl shall not under any circumstances, be liable for any special, incidental, or consequential damages, including, but not limited to, damages or loss of other property of equipment, loss of profits or revenue, cost of purchased or replacement goods, or claims of customers of the purchaser which may arise and/or result from the sales, installation or use of these parts.

Ring Specification Sheet

The following are guidelines for ring installation

Certain applications may require different clearances. Consult the enclosed charts and diagrams before installing rings.

Ring Gap Measuring Procedures

1. A torque plate should be installed on engine (if applicable) and torqued to specifications.
2. Piston ring should be below and square to the deck. (Figure 1)
3. Measure ring gap with a feeler gauge or equivalent measuring device. (Figure 2)



PISTONS

Tel: 949.567.9000 Fax: 949.567.9010

1902 McGaw, Irvine, CA 92614

www.cppistons.com

Member of Pankl Racing Systems

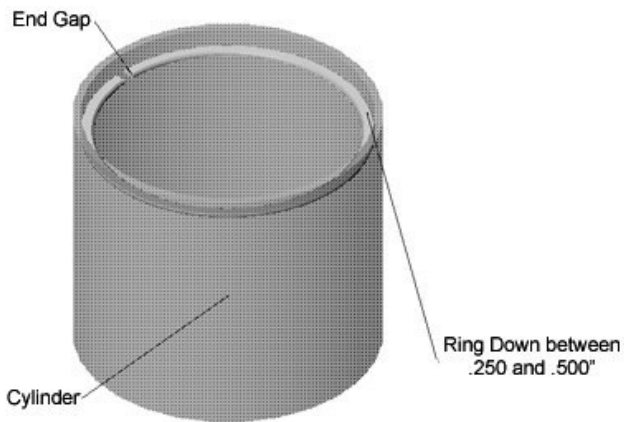

Figure 1

NOTE

If the ring gap is less than the minimum specified for your bore size, it will be necessary to file fit the rings to achieve proper end gap.

Ring Filing Procedures

1. Ring gap should be filed using a ring gap filing tool.
2. Ring gap should be file in an inward direction and square to the sides.

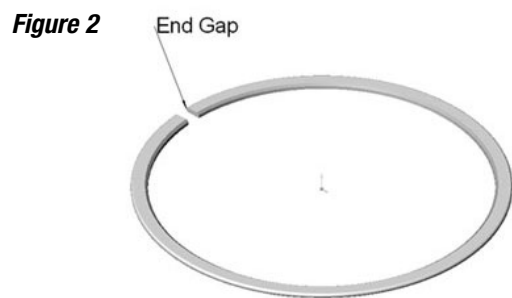

Figure 2

Important: Ring sets are manufactured to fit specific bores. For every .001" over the intended bore size, ring gap will increase by .00314"

Ring Gap Measuring Procedures

Always use an installation tool when installing rings

Top Ring

1. If the ring has a dot or writing on it, install with this side up.
2. Unmarked rings with inner bevel are installed bevel side up.
3. Rings without dot, writing or bevel install either side up.

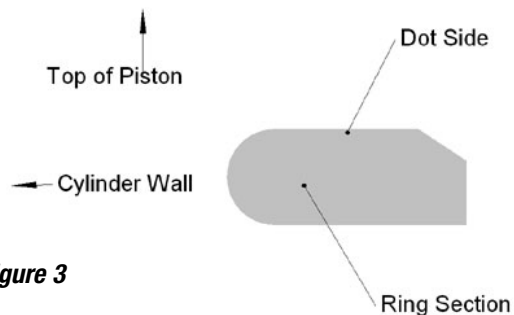

Figure 3

Second Ring

1. If the ring has a dot or writing on it, install with this side up.
2. If the ring is a taper hook groove style, the groove always goes down. (Figure 4)
3. Unmarked rings with an inner bevel install bevel side down. (Figure 5)
4. Rings without a dot or inner bevel install either side up.

Typical Taper Hooked Ring Layout

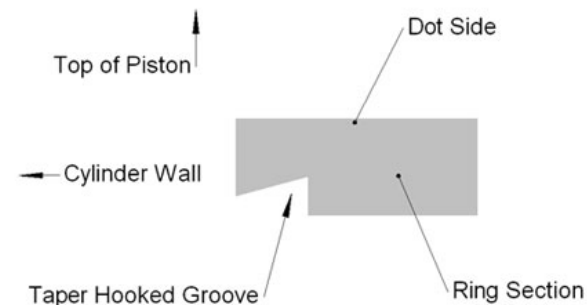

Figure 4

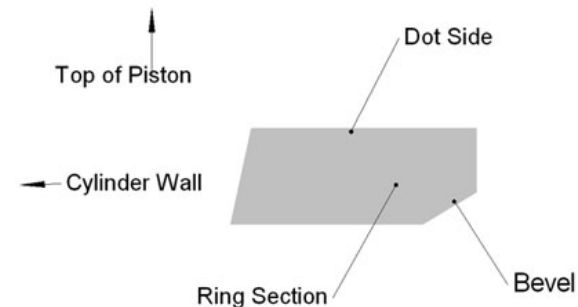

Figure 5

Oil Ring

1. Most CP oil rings are three piece – two rails and an expander.
2. End gaps on rails should not be less than .015" and should not overlap.
3. Do not modify expander in any way.

